

# User Guide

## Elcometer 266

### DC Holiday Detector

## CONTENTS

---

- 1 Working Safely
- 2 Gauge Overview
- 3 Box Contents
- 4 Using the Gauge
- 5 Getting Started
- 6 High Voltage Probe Handle
- 7 Preparing for Test
- 8 Test Procedure
- 9 Setting the Probe Handle Voltage
- 10 Setting the Sensitivity
- 11 Static Electricity
- 12 Probe Accessory Selection
- 13 The Second Hand Grip
- 14 Special Considerations
- 15 Error Messages
- 16 Spares & Accessories
- 17 Warranty Statement
- 18 Technical Specification
- 19 Care & Maintenance
- 20 Legal Notices & Regulatory Information
- 21 Appendix A: Standards
- 22 Appendix B: Calculating The Correct Test Voltage



For the avoidance of doubt, please refer to the original English language version.

Kit Dimensions: 520 x 370 x 125mm (20.5 x 14.5 x 5")

Weight: Base Unit (including battery pack): 1.2kg (2.7lb); Handle: 0.6kg (1.3lb)

Base Unit, Handle & Connecting Cable: 2kg (4.4lb)

A Material Safety Data Sheet for the Elcometer 266 Battery Pack is available to download via our website:

[http://www.elcometer.com/images/stories/MSDS/elcometer\\_266\\_280\\_battery\\_pack.pdf](http://www.elcometer.com/images/stories/MSDS/elcometer_266_280_battery_pack.pdf)

© Elcometer Limited 2010-2016. All rights reserved. No part of this document may be reproduced, transmitted, transcribed, stored (in a retrieval system or otherwise) or translated into any language, in any form or by any means (electronic, mechanical, magnetic, optical, manual or otherwise) without the prior written permission of Elcometer Limited.

## 1 WORKING SAFELY

---



The equipment should be used with extreme care. Follow the instructions given in this user guide. Caution - risk of electric shock.

The high voltage handle generates a voltage at the probe tip of up to 30 000 V. If the user makes contact with the probe, it is possible to experience a mild electric shock. Due to the current being very low, this is not normally dangerous, nevertheless Elcometer does not advise using this product if you are fitted with a pacemaker.

An electrical spark indicates detection of a coating flaw; do not use this instrument in hazardous situations and environments, e.g. an explosive atmosphere.

Due to its method of operation, the Elcometer 266 will generate broad band RF emissions when a spark is produced at the probe, i.e., when a flaw in the coating is located. These emissions may interfere with the operation of sensitive electronic apparatus in the vicinity. In the extreme case of a continuous spark of length 5mm, the magnitude of emissions at a distance of 3m was found to be approximately 60 dB $\mu$ V/m from 30 MHz to 1000 MHz. It is therefore recommended that this equipment is not operated within 30m of known sensitive electronic equipment and that the user does not deliberately generate continuous sparks.

In order to avoid injury and damage, the following should always be observed:

- × **DO NOT** use this instrument in hazardous situations and environments, e.g. any combustible, flammable or other atmosphere where an arc or spark may result in an explosion.
- × **DO NOT** carry out tests close to moving machinery.
- × **DO NOT** use the instrument in a precarious, unstable or elevated situation from which a fall may result, unless a suitable safety harness is used.
- × **DO NOT** use this product if you are fitted with a pacemaker.
- × **DO NOT** use this product when it is raining, in a damp atmosphere or if the unit is wet.

## 1 WORKING SAFELY (continued)

---

- ✓ DO read and understand these instructions before using the equipment.
- ✓ DO charge the battery before the first use of the equipment. This will take approximately 4 hours, see Section 5.1 'Charging the Battery Pack' on page en-7.
- ✓ DO consult the plant or safety officer before carrying out the test procedure.
- ✓ DO undertake testing well clear of other personnel.
- ✓ DO work with an assistant to keep the test area clear and to help with the testing procedure.
- ✓ DO check that there are no solvents or other ignitable materials from the coating activities left in the test area, particularly in confined areas such as tanks.
- ✓ DO switch the instrument off and disconnect the leads when the work is finished and before leaving it unattended.
- ✓ DO ensure that the earth signal return cable is connected and extended before you switch on the instrument.
- ✓ DO only use on coatings that are cured, thickness tested and visually inspected and accepted.
- ✓ DO only use on coatings having a dry film thickness of at least 200µm (0.008"). For thicknesses between 200µm and 500µm (0.008" to 0.020"), ensure that an appropriately low voltage is applied (to prevent damage to the coating), or use the wet sponge method (using the Elcometer 270).
- ✓ DO bond the work piece to a ground potential to minimise the potential for build up of static charge, see Section 11 'Static Electricity' on page en-21.
- ✓ DO take care when using this product with coatings that are damp or wet.
- ✓ DO dry the instrument if it gets wet, paying special attention to the ribbing area.

## 2 GAUGE OVERVIEW

---

The Elcometer 266 detects flaws in protective coatings up to 7mm (25mils) thick and is ideal for inspecting coatings on pipelines and other protective coatings.

The coating under test can be electrically non-conductive or partially conductive (such as coatings which contain metallic or carbon particles). The coating must be at least 200µm (0.008") thick, and preferably over 500µm (0.020"), thick.

The underlying substrate must be an electrically conductive material such as metal or concrete (concrete is reasonably conductive because of its water content).

Typical flaws are pinholes (a very narrow hole running from the coating surface to the substrate), holidays (small uncoated areas), inclusions (objects trapped in the coating, e.g. grit from blast cleaning), air bubbles, cracks and thin spots.

The Elcometer 266 probe handle generates a high DC voltage which is applied to the surface of the coating via a probe. An earth signal return cable is connected between the instrument and the substrate. When the probe is passed over a coating flaw, the electrical circuit is completed and current flows from the probe to the substrate. As a result, the instrument gives audible and visual alarms and a spark may be produced at the flaw.

The user can perform the test to any one of a number of international testing standards using the built-in Voltage Calculator.

The Elcometer 266 features an easy to use menu-driven graphical interface which guides the user during setup of the instrument and during measurement.

The instrument will operate in one of three voltage ranges; 0.5 kV to 5 kV, 0.5 kV to 15 kV and 0.5 kV to 30 kV. The voltage range is determined by the model of high voltage probe handle fitted to the instrument - not the instrument itself.

## 2 GAUGE OVERVIEW (continued)

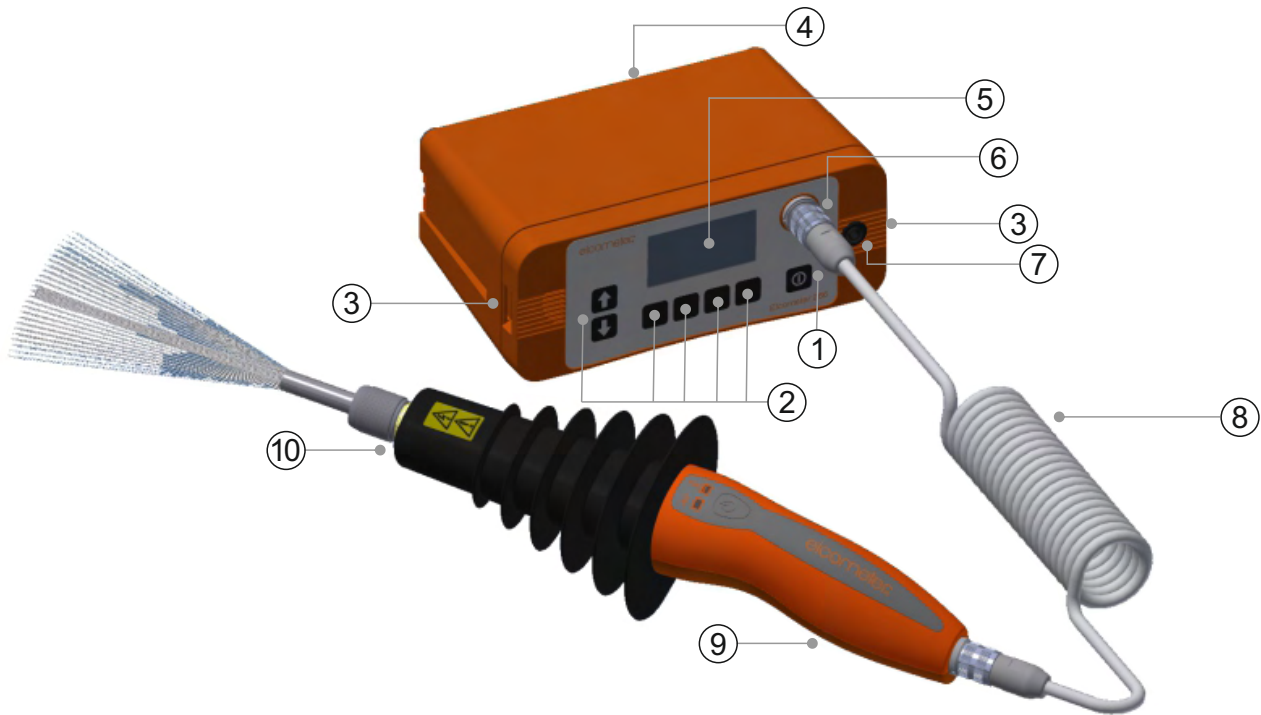

- 1 On/Off Key
- 2 Multi Function Menu Keys
- 3 Shoulder Strap Connection
- 4 Rechargeable Lithium-ion Battery Pack
- 5 LCD Display
- 6 High Voltage Probe Handle Connection
- 7 Earth Signal Return Cable Connection
- 8 High Voltage Probe Handle Connecting Cable
- 9 High Voltage Probe Handle
- 10 Probe Accessory Connection

## 3 BOX CONTENTS

- Elcometer 266 DC Holiday Detector
- Earth Signal Return Lead, 10m (32 ft)
- Connecting Cable for High Voltage Probe Handle<sup>a</sup>
- Band Brush Probe
- Rechargeable Lithium-ion Battery Pack
- Battery Charger (UK, EU, US and AUS plugs included)
- Shoulder Strap
- Transit Case
- Calibration Certificate (if ordered)
- User Guide

<sup>a</sup> High voltage probe handle must be ordered separately - see Section 6 'High Voltage Probe Handle' on page en-11.

## 4 USING THE GAUGE

### 4.1 THE CONTROLS

The Elcometer 266 is operated using the keypad on the instrument and the button on the high voltage probe handle.

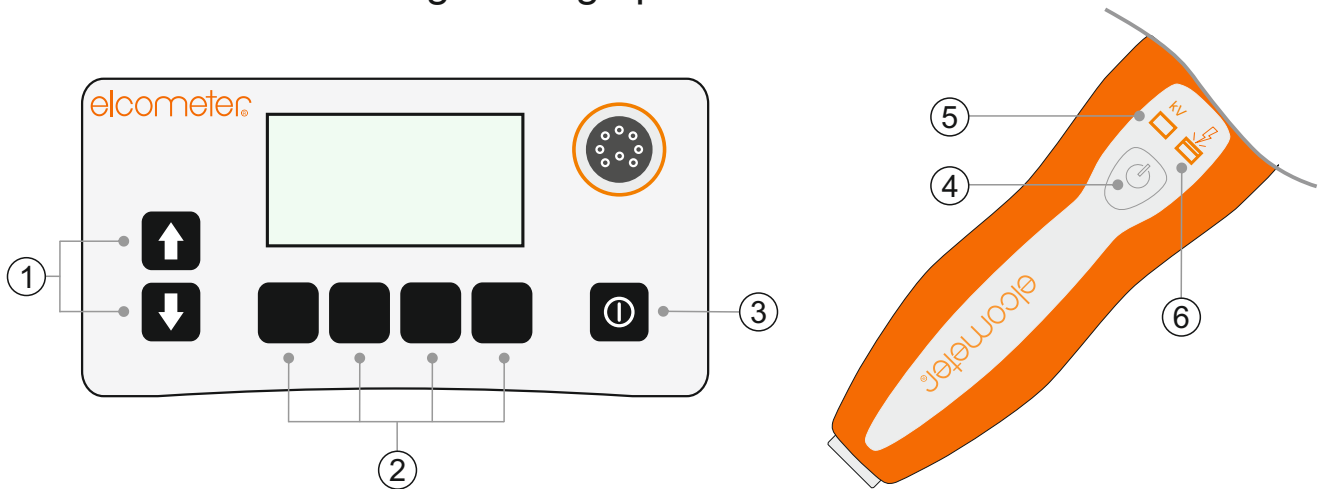

- 1 Scroll up / down through menus and lists of values  
Increases / Decreases Values
- 2 The function of these keys varies and is shown on the display
- 3 Switches the instrument on / off
- 4 Press to toggle high voltage probe handle on / off
- 5 Red light: Probe voltage is on
- 6 Blue light: Flaw detected

### 4.2 THE DISPLAY

The main screen displayed (whilst taking measurements) is the Reading Screen.

- a Current: Measured Value
- b Current: Set Value
- c Voltage: Measured Value
- d Voltage: Set Value
- e Calculate Voltage
- f Adjust Voltage
- g Adjust Sensitivity
- h View Menu
- i Voltage Locked (see page en-11)
- j Sensitivity Locked (see page en-11)
- k Battery Life Indicator

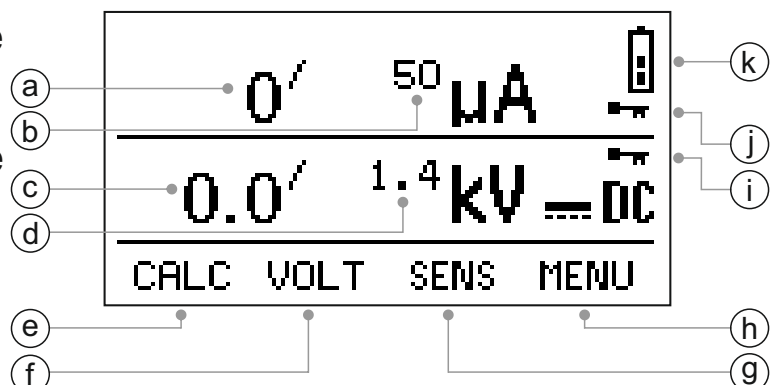



## 5 GETTING STARTED

### 5.1 CHARGING THE BATTERY PACK

The Elcometer 266 is powered by a rechargeable Lithium-Ion<sup>b</sup> battery pack which can be charged inside or outside the instrument.

Each instrument is dispatched from the factory with the battery discharged. Recharge the battery fully before using for the first time.

*Note: Only one battery pack is supplied with each instrument. To increase productivity on site, we recommend purchasing a spare battery pack which can be charged whilst the instrument is in use, see Section 16.3 'Batteries, Chargers & Earth Signal Return Leads' on page en-28.*

#### Before you start:

- Use only the charger supplied with the Elcometer 266 to charge the battery. Use of any other type of charger is a potential hazard, may damage your instrument and will invalidate the warranty. Do not attempt to charge any other batteries with the supplied charger.
- Always charge the battery indoors.
- To prevent overheating, ensure that the charger is not covered.
- The instrument can be charged whilst it is switched on or off. If charged whilst switched on, the high voltage supply to the probe will be disconnected automatically and a battery charging icon will be shown on the display. If charged whilst switched off, the display will remain blank.



**WARNING:** Do not attempt to connect the supply side of the battery charger to generators or any other medium to high power source other than the single phase 50Hz A.C. mains outlet supplied from an approved and safe mains switchboard. Connection to other supply sources such as generators or inverters may have the potential to damage the charger, the battery and/or the instrument invalidating the warranty.

#### Charging the battery pack inside the instrument:

- 1 Unscrew the retaining screw (a) and open the access cover on the rear of the instrument.
- 2 Connect the lead from the charger into the socket marked 'Charger Input' behind the interface access cover.



<sup>b</sup> The Elcometer 266 is **not** designed to operate using dry cell batteries.



## 5 GETTING STARTED (continued)

- 3 Plug the charger supplied into the mains supply. The LED indicator on the charger will glow orange.
- 4 Leave the gauge charging for at least 4 hours. The LED indicator changes colour from orange to green when charging is complete.
- 5 When charging is complete, disconnect the charger from the mains supply before removing the lead from the instrument.

### Charging the battery pack outside the instrument:

- 1 Unscrew the two battery pack retaining screws at the rear of the instrument and slide out the battery pack.
- 2 Connect the lead from the charger into the socket on the battery pack.
- 3 Plug the charger supplied into the mains supply. The LED indicator on the charger will glow orange.
- 4 Leave the battery pack charging for at least 4 hours. The LED indicator changes colour from orange to green when charging is complete.
- 5 When charging is complete, disconnect the charger from the mains supply before removing the lead from the battery pack.



Whilst the battery pack is removed from the instrument, do not allow metallic objects to come into contact with the battery terminals; this may cause a short circuit and result in permanent damage to the battery.

The battery condition is indicated by a symbol on the display:

Symbol	Battery Charge / Action Required
	70% to 100%
	40% to 70%
	20% to 40%
	10% to 20% - charging recommended
	<10%, instrument beeps every 10 seconds and symbol flashes - immediate charging required
	5 loud beeps, instrument switches off automatically

## 5 GETTING STARTED (continued)

### 5.2 SWITCHING THE INSTRUMENT ON / OFF

**To switch on/off:** Press the On/Off button 'ⓘ'.

*Note: To extend battery life (time between charges) the instrument can be set to switch off automatically after a user defined period of inactivity between 1 and 15 minutes. The default setting is 15 minutes.*

### 5.3 SELECTING YOUR LANGUAGE

- 1 Press the MENU key to display the main menu.
  - ▶ When the instrument is switched on for the first time after despatch from the Elcometer factory, the language selection screen will be displayed. Proceed to Step 2.
- 2 Select your language using the ↑↓ keys.
- 3 Press SEL to activate the selected language.

To access the language menu when in a foreign language:

- 1 Switch the instrument OFF.
- 2 Press and hold the left hand key and switch the instrument ON. The display will show the language selection screen with the current language highlighted by the cursor.
- 3 Select your language using the ↑↓ keys.
- 4 Press SEL to activate the selected language.

### 5.4 CONFIGURING THE INSTRUMENT

- 1 Press the MENU key to display the main menu.
- 2 Use the ↑↓ keys to scroll up and down the menu items.
- 3 Press SEL to activate the selected option or access the sub-menu, see Table 1.
- 4 Press BACK or ESC to leave the main menu or any sub-menu.

**TABLE 1**

Option	Action Required
BACKLIGHT	Press SEL to toggle the display backlight on or off.
BEEP VOLUME	Press SEL followed by ↑ or ↓ to set the beep volume; 1 (minimum) to 5 (maximum). Press OK when finished.
UNITS	Press SEL followed by ↑ or ↓ to select the measurement units; μm, mm, mil, thou or inch. Press OK when finished.
LANGUAGES	Press SEL followed by ↑ or ↓ to select the display language. Press OK when finished.

## 5 GETTING STARTED (continued)

**TABLE 1**

Option	Action Required
ABOUT	Press SEL to view the ABOUT menu.
RESET	Press SEL to view the RESET menu
AUTO SWITCH OFF	Press SEL followed by + or - to set the auto switch off delay; 1 to 15 minutes or off (X). Press OK when finished.
OPENING SCREEN	Press SEL to toggle the opening screen on or off.
VOLTAGE LOCKED	Press SEL to toggle the voltage lock on or off, see Section 5.6 'Voltage and Sensitivity Locks' on page en-11.
SENSITIVITY LOCKED	Press SEL to toggle the sensitivity (current) lock on or off, see Section 5.6 'Voltage and Sensitivity Locks' on page en-11.

### 5.5 CLICKS, BEEPS, ALARMS AND LIGHTS

The Elcometer 266 emits a range of sounds and lights whilst in use, see Table 2 below.

**TABLE 2**

Sound	Lights	Indicates
Single beep - high pitch	Red light on high voltage probe handle illuminates	High voltage to probe is switched on
Double beep - high pitch	Red light on high voltage probe handle flashes on/off	The safety interlock on the high voltage probe handle is not being gripped by your hand
Clicks - continuous series of	Red light on high voltage probe handle is illuminated	High voltage is present at the probe
Alarm buzzing	Blue light on high voltage probe handle flashes on/off	Flaw detected

## 5 GETTING STARTED (continued)

### 5.6 VOLTAGE AND SENSITIVITY LOCKS

The voltage and sensitivity settings on the Elcometer 266 include a 'lock' feature which helps to prevent accidental changes to these values once they have been set.

- The voltage lock can be toggled on or off from the main menu, see Section 5.4 'Configuring the Instrument' on page en-9. The voltage lock also switches on automatically once the voltage has been set using CALC.
- The sensitivity lock can be toggled on or off from the main menu, see Section 5.4 'Configuring the Instrument' on page en-9.

If a voltage or sensitivity lock is switched on, it can be overridden during setting of the value by pressing the UNLOCK key. The lock will re-engage automatically once the value has been set.

## 6 HIGH VOLTAGE PROBE HANDLE

A range of interchangeable high voltage probe handles is available for the Elcometer 266. A label on the underside of the handle indicates the maximum working voltage of the handle (5 kV, 15 kV or 30 kV).



The choice of which high voltage probe handle to use depends upon the maximum test voltage required, which in turn depends upon the thickness of the coating being tested and the recommendations of any test standard which may be being followed.

The Elcometer 266 is not supplied with a probe handle, these must be ordered separately.

Description	Voltage	Part Number
Elcometer 266 Probe Handle, DC5	0.5 - 5 kV	T26620033-1
Elcometer 266 Probe Handle, DC15	0.5 - 15 kV	T26620033-2
Elcometer 266 Probe Handle, DC30	0.5 - 30 kV	T26620033-3
Elcometer 266 Probe Handle, DC30S (Continuous Voltage)	0.5 - 30 kV	T26620033-4

*Note: The DC30S Continuous Voltage Probe Handle is compatible with Elcometer 266 instruments with serial numbers 'SC16119' onwards. The software in older instruments must be updated by Elcometer or your local Elcometer distributor to recognise the new DC30S handle.*

## 6 HIGH VOLTAGE PROBE HANDLE (continued)

### 6.1 CONNECTING A HIGH VOLTAGE PROBE HANDLE

The instrument must be switched off when a high voltage probe handle is fitted or removed.

Connect the high voltage probe handle to the instrument using the supplied connecting cable (the grey curly cable). The connecting cable is fitted with a metal screw-type connector at each end. To fit a connector, align the keyway, push the connector into place and then tighten the metal collar.

If the instrument is switched on without a high voltage handle fitted a warning message is displayed.



### 6.2 HIGH VOLTAGE PROBE HANDLE SAFETY INTERLOCK

All high voltage probe handles (with the exception of the DC30S Continuous Voltage Probe Handle, see Section 6.3 on page en-13) are fitted with a safety interlock device.

The safety interlock is fitted inside the black rubberised grip on the underside of the high voltage probe handle.

When this section of the handle is held by the hand as shown, the interlock switch is released and the voltage to the probe can be switched on (by pressing the button on the handle).

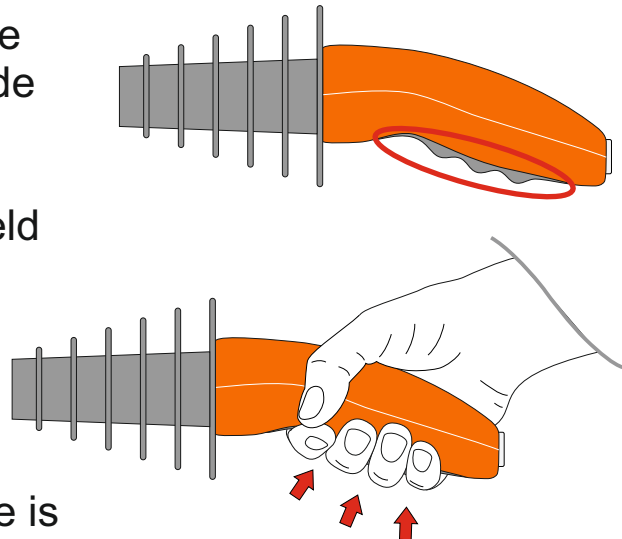

If the grip is released whilst the probe is at high voltage:

- the voltage at the probe will drop to zero immediately,
- the instrument will emit a high pitched beep, and
- the red light on the handle will flash.

## 6 HIGH VOLTAGE PROBE HANDLE (continued)

If the grip is then grasped again within approximately two seconds the voltage at the probe will be immediately restored. This feature allows the user to adjust their grip as required without interruption.

If the grip is not grasped within this two second interval, the high voltage probe handle is switched off automatically. To continue testing, grasp the handle again and press the button on the handle.

### 6.3 DC30S CONTINUOUS VOLTAGE PROBE HANDLE

The DC30S probe handle does not have the safety interlock feature.

To switch off the voltage output, press the On/Off key (a) on the top of the handle. Alternatively, switch off the Elcometer 266 instrument using the On/Off key (b).

To connect the handle to the instrument, follow the instructions outlined in Section 6.1 'Connecting a High Voltage Probe Handle' on page en-12.

When a DC30S probe handle is connected to the instrument, a warning message is displayed each time the instrument is switched on. Press OK to acknowledge and continue operating as normal.

*Note: The DC30S Continuous Voltage Probe Handle is compatible with Elcometer 266 instruments with serial numbers 'SC16119' onwards. The software in older instruments must be updated by Elcometer or your local Elcometer distributor to recognise the new DC30S handle.*

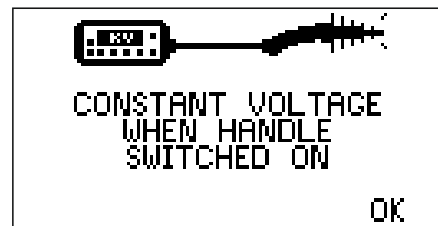
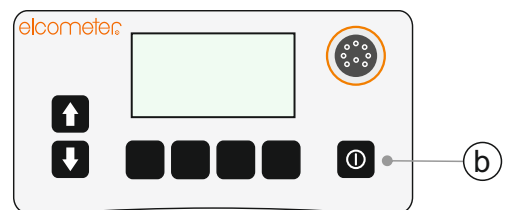

## 7 PREPARING FOR TEST



Please read the information in Section 1 'Working Safely' on page en-2 before using the equipment. If in doubt, contact Elcometer or your local Elcometer supplier.

### 7.1 CONNECT THE CABLES

- 1 Connect the high voltage probe handle to the instrument using the grey curly cable (Figure 1).
- 2 Connect the clamp of the earth signal return cable to an exposed section of substrate. Plug the other end of the cable into the instrument (Figure 2).

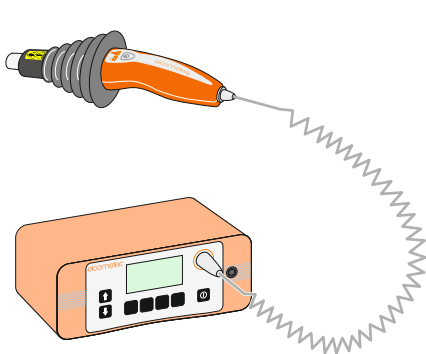

Figure 1

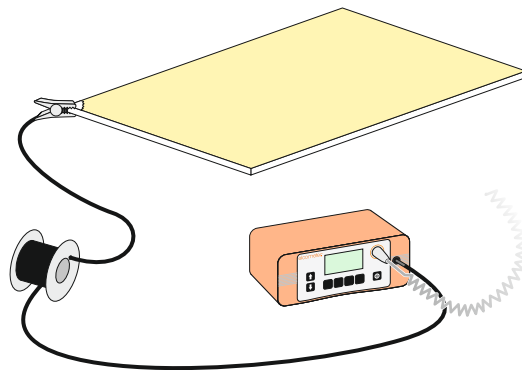

Figure 2

### 7.2 FIT THE PROBE ACCESSORY

Select the probe accessory best suited for the work being undertaken, see Section 12 'Probe Accessory Selection' on page en-22, and attach it to the high voltage probe handle (Figure 3).

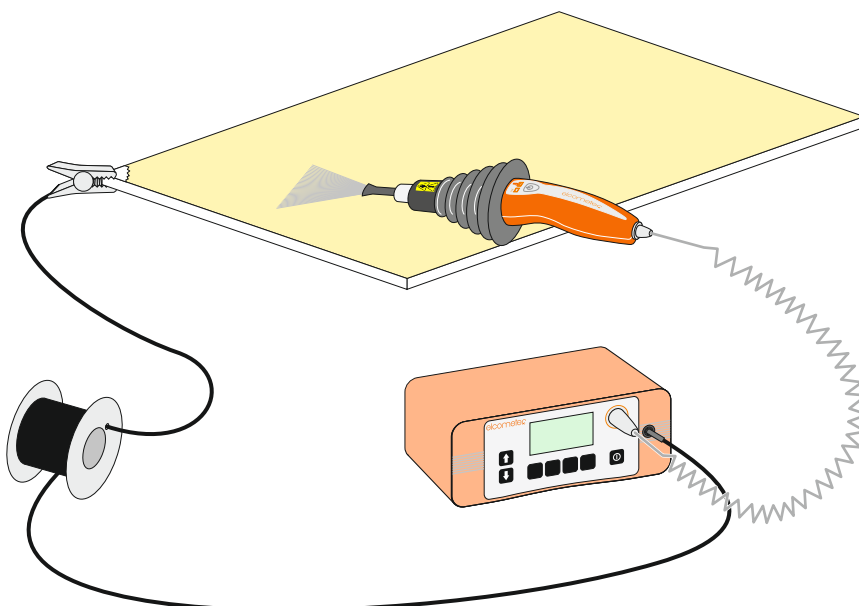

Figure 3



## 7 PREPARING FOR TEST (continued)

---

### 7.3 CHECK THE CABLE CONNECTIONS

- 1 Press the On/Off button to switch the instrument on.
- 2 Reduce the voltage setting to the minimum value, see Section 9 'Setting the Probe Handle Voltage' on page en-17.
- 3 Reduce the current setting to the minimum value, see Section 10 'Setting the Sensitivity' on page en-19.
- 4 Hold the high voltage probe handle firmly with the probe in free air and press the button on the handle to switch on.
- 5 Touch the probe against the bare substrate and check that the instrument signals a flaw.
  - (a) If the instrument signals a flaw then the instrument is operating correctly and is ready to use for testing.
  - (b) If the instrument does not signal a flaw check all connections and try again. If you are still unable to get the instrument to signal a flaw, contact Elcometer or your local Elcometer supplier for advice.
- 6 When finished, press the button on the probe handle to switch off.

### 7.4 SET THE PROBE HANDLE VOLTAGE

See Section 9 'Setting the Probe Handle Voltage' on page en-17.

### 7.5 SET THE SENSITIVITY

See Section 10 'Setting the Sensitivity' on page en-19.

### 7.6 CHECK FOR CORRECT OPERATION

- 1 Either find or make a flaw in the coating.
- 2 Using the procedure outlined in Section 8 'Test Procedure' on page en-16, test that the flaw can be detected.
- 3 If the flaw is not detected, confirm that all the preceding steps have been undertaken correctly and check again.
- 4 If the flaw is still not detected, contact Elcometer or your local Elcometer supplier for advice.

## 8 TEST PROCEDURE

### 8.1 TESTING IN A SINGLE LOCATION

- 1 Holding the high voltage probe handle firmly, ensure that your fingers grasp and squeeze the black rubberised grip on the underside of the handle, as shown (Figure 4).
- 2 With the probe in free air, press and release the button on the handle to switch on the high voltage. The red light on the handle will illuminate and the instrument will emit a regular clicking, indicating that the probe is at high voltage.
- 3 Place the probe on the test surface.
- 4 Keeping the probe in contact<sup>c</sup> with the surface, move it over the work area at a speed of approximately one metre every four seconds, 0.25m/s (10"/s).

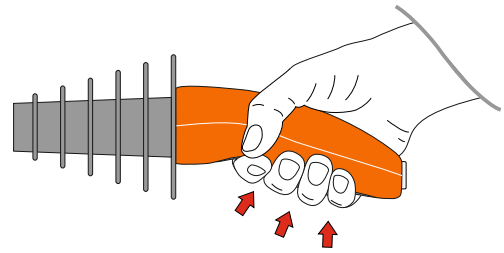
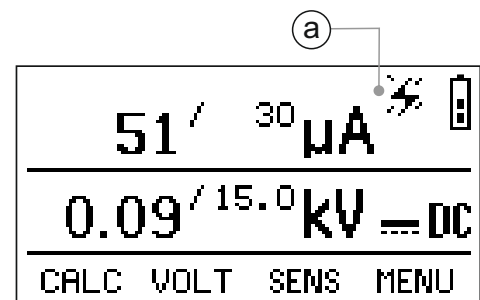

Figure 4

Any flaws in the coating will be indicated by one or more of the following:

- (a) A spark is seen between the probe and the surface
- (b) The blue light on the high voltage handle flashes
- (c) The alarm sounds
- (d) The alarm icon is shown on the display (a)
- (e) The display backlight flashes



### 8.2 MOVING TO A NEW TEST LOCATION

If you need to test in more than one location:

- 1 Always switch off the instrument before disconnecting any cables.
- 2 After reattaching cables in the new test location and before you recommence testing, repeat the steps given in Sections 7.3, 7.4 and 7.5 on page en-15.

<sup>c</sup> The probe must always touch the surface. Gaps between the probe and the coating can result in genuine flaws not being detected.

## 8 TEST PROCEDURE (continued)

### 8.3 AFTER TEST

Always switch off the instrument and disconnect the cables when you have finished testing and when leaving work unattended.

## 9 SETTING THE PROBE HANDLE VOLTAGE

The probe handle voltage can be set automatically or manually.

### 9.1 AUTOMATICALLY SETTING THE VOLTAGE

The Elcometer 266 includes a built-in Voltage Calculator which will determine and set the correct test voltage based upon the test standard and the thickness of coating you are testing.

Using the Voltage Calculator is a two stage process;

- First select your test standard and;
- then select your coating thickness.

#### To select the test standard:

- 1 With the reading screen displayed, press the CALC key. The 'VOLTAGE CALCULATOR' screen will be displayed. The current test standard selected is shown.
  - ▶ If the voltage has been locked, see Section 5.6 'Voltage and Sensitivity Locks' on page en-11, a warning screen will be displayed; press UNLOCK to allow the voltage to be adjusted - the lock will re-engage automatically after the voltage has been set by the calculator.
- 2 Press STD to display a list of test standards, see also Appendix A 'Standards' on page en-35.
- 3 Using the  $\uparrow\downarrow$  keys, move the arrow to the required test standard then press OK. The selected test standard will be shown.

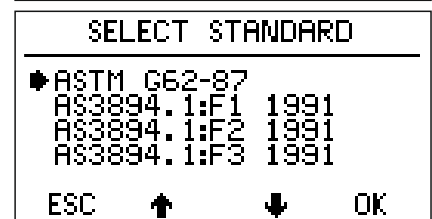
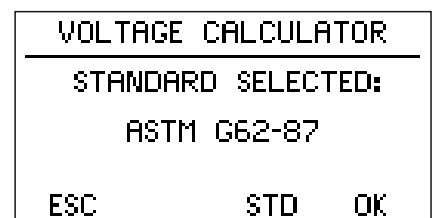

## 9 SETTING THE PROBE HANDLE VOLTAGE (continued)

### To select the coating thickness:

- 1 With the Voltage Calculator showing the test standard selected, press OK. The 'SET THICKNESS' screen will show the last used coating thickness and the upper and lower thickness values for the test standard selected.
- 2 Using the  $\uparrow\downarrow$  keys, adjust the coating thickness to the required value and then press OK. A confirmation screen is shown which displays the selected test standard, the coating thickness and the calculated test voltage.
- 3 Press OK to set the instrument voltage to the calculated value, otherwise to return to the reading screen without making any changes, press ESC.

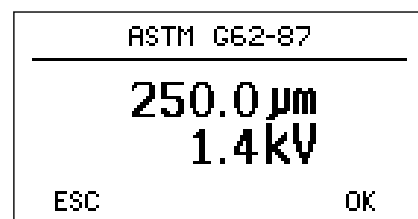
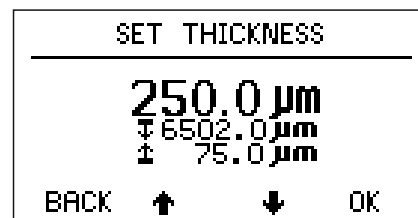
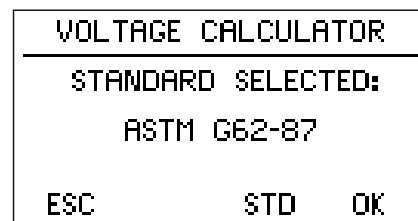

The calculated value of voltage will be shown on the reading screen (a) and a key icon will appear to indicate that the voltage has been locked (b).

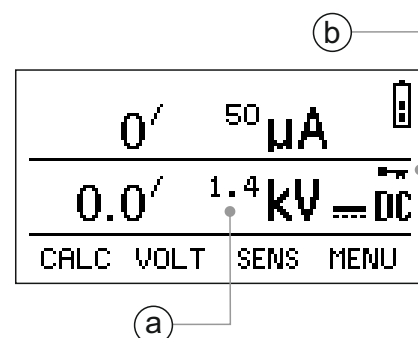

### 9.2 MANUALLY SETTING THE VOLTAGE

Before you start, read the notes given in Appendix B 'Calculating the Correct Test Voltage' on page en-38.

- 1 With the reading screen displayed, press the VOLT key. The 'SET TEST VOLTAGE' screen will be displayed.
  - ▶ If the voltage has been locked, see Section 5.6 'Voltage and Sensitivity Locks' on page en-11, a warning screen will be displayed; press UNLOCK to allow the voltage to be adjusted - the lock will re-engage automatically after the voltage has been set by the calculator.

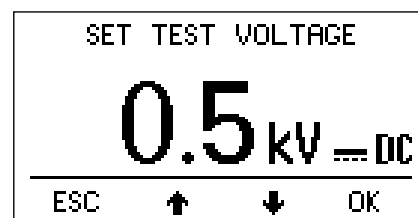

## 9 SETTING THE PROBE HANDLE VOLTAGE (continued)

- 2 Using the  $\uparrow\downarrow$  keys, adjust the voltage to the required value. The keys on the left of the display (a) adjust in increments of 1 kV; the keys below the display (b) adjust in increments of 0.1 kV.
  - ▶ Press and hold any of these keys to advance rapidly.
- 3 Press OK when finished.

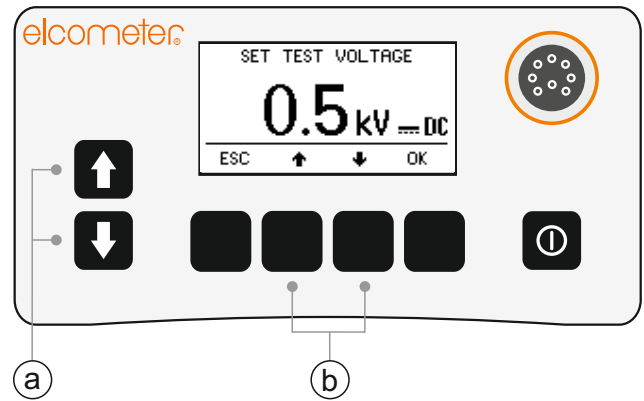

The new probe set voltage will be displayed on the reading screen (a). If the voltage lock is active, see Section 5.6 'Voltage and Sensitivity Locks' on page en-11, a key icon indicates that the voltage is locked (b).

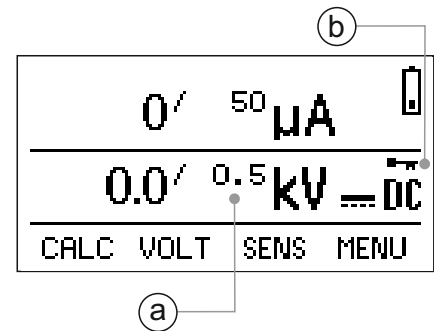

## 10 SETTING THE SENSITIVITY

The sensitivity can be set automatically or manually.

### 10.1 AUTOMATICALLY SETTING THE SENSITIVITY

When the Elcometer 266 is set to automatic sensitivity mode, the instrument measures the current returning via the earth signal return cable.

If significant changes in the current are detected, the instrument analyses these changes - looking for the electrical 'signature' of a coating flaw.

When such a signature is detected, the instrument will signal the presence of the flaw.

Auto mode is beneficial when conductive coatings are being tested.

If the set value of the current on the reading screen is displayed as 'AUTO  $\mu$ A', the instrument is already set to automatic sensitivity mode and you need do nothing more.

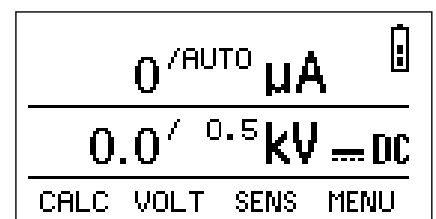

## 10 SETTING THE SENSITIVITY (continued)

### If 'AUTO' is not displayed:

- 1 Press the SENS key. The 'SET SENSITIVITY' screen will be displayed.
- 2 Press AUTO (a) to switch to automatic sensitivity mode.
- 3 Press OK to return to the reading screen.
- 4 Check that 'AUTO' is now displayed as the set value of the current.

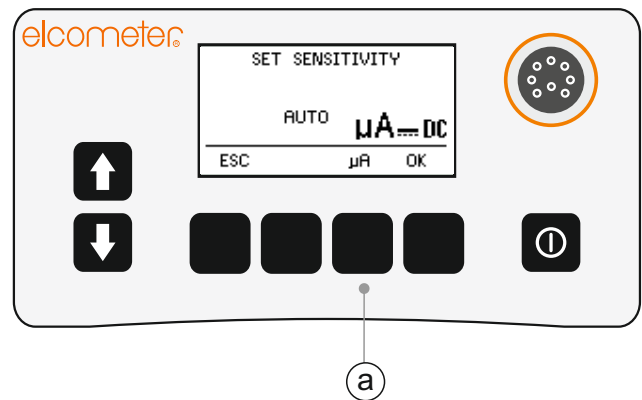

### 10.2 MANUALLY SETTING THE SENSITIVITY

Manual setting of sensitivity may be required in certain instances and to comply with some test standards. To set the sensitivity of the instrument manually, the set current value must be adjusted.

The set current value is adjustable between 5  $\mu\text{A}$  and 99  $\mu\text{A}$  in 1  $\mu\text{A}$  increments.

- As the value is increased towards its maximum (99  $\mu\text{A}$ ), the instrument becomes LESS sensitive.
- As the value is decreased towards its minimum (5  $\mu\text{A}$ ), the instrument becomes MORE sensitive.

Typically, manual adjustment may be required when testing partially conductive coatings at high voltages.

The probe is placed onto a section of coating known not to contain any flaws. The measured 'background' current flow is noted and the set current value then adjusted to a value a few  $\mu\text{A}$  above this figure. Erroneous alarms due to the background current flow are therefore avoided in this instance.

- 1 With the reading screen displayed, press the SENS key. The 'SET SENSITIVITY' screen will be displayed.
  - ▶ If the sensitivity has been locked, see Section 5.6 'Voltage and Sensitivity Locks' on page en-11, a warning screen will be displayed; press UNLOCK to allow the current to be adjusted - the lock will re-engage automatically after the current has been set.

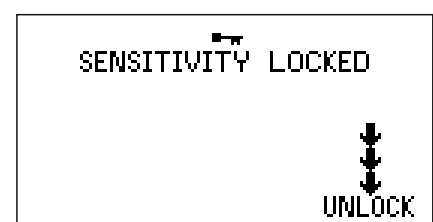

## 10 SETTING THE SENSITIVITY (continued)

- 2 If the sensitivity is set to 'AUTO  $\mu$ A', press ' $\mu$ A'. The last used set current value will be displayed.
- 3 Using the  $\uparrow$  $\downarrow$  keys, adjust the set current to the required value; each press changes the display by 1  $\mu$ A.
  - ▶ Press and hold either key to advance rapidly.
- 4 Press OK when finished.

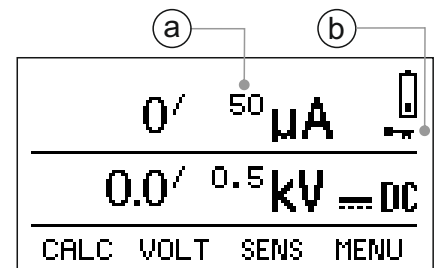
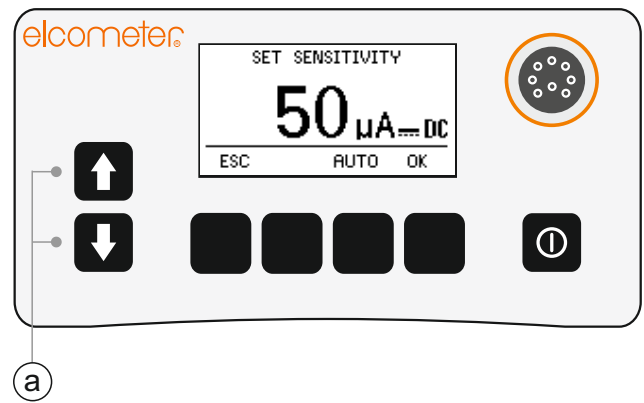

The new set current will be displayed on the reading screen (a). If the sensitivity lock is active, see Section 5.6 'Voltage and Sensitivity Locks' on page en-11, a key icon indicates that the sensitivity is locked (b).

## 11 STATIC ELECTRICITY

As the probe is moved over the surface of a coating, a static charge builds up which can:

- Cause objects in contact with the surface to become charged with the same polarity.
- Induce an opposite charge on nearby objects electrically insulated from the surface.

Charged surfaces (or adjacent objects) can be discharged by turning off the high voltage and brushing the surface with the probe.

Induced static on the operator is minimised by means of a dissipative contact point on the high voltage probe handle (the rubber handgrip). Simply holding the handle ensures that the operator is always at the same potential as the earth signal return cable, and therefore the test substrate.

It is recommended that the substrate of the item being tested is bonded to an earth potential, thus preventing any overall build-up of charge, which can otherwise remain on an isolated test piece for several minutes after testing has been completed.



## 11 STATIC ELECTRICITY (continued)

The wearing of rubber gloves and insulating footwear is not necessary, although in certain unusual circumstances there may be a benefit.

For further guidance on minimising the effect of static, contact Elcometer or your Elcometer supplier.

## 12 PROBE ACCESSORY SELECTION

Table 3 below shows the most suitable probe accessory to use depending on the characteristics of the surface to be tested, e.g. internal and external pipe surfaces, large surfaces and complex shapes.

In addition, long reach applications can be carried out using extension pieces that are suitable for use with all probe types.

All these probe accessories are available from Elcometer or your local Elcometer supplier, see Section 16 'Spares & Accessories' on page en-27 for details.

<b>Type of Surface</b>	<b>Recommended Probe</b>	<b>Notes</b>
Small area, complex surface, general application	Band brush probe	Provides low contact pressure
Large surface areas	Wire brush probe/Rubber probe	Available in different widths. Use rubber probe for light contact and wire brush probe for medium contact
Insides of pipes 40mm to 300mm (1.5" to 12") diameter	Circular brush probe	Includes 250mm (9.8") extension rod
Outside of pipes, 50mm to 1000mm (2" to 36") diameter	Rolling spring probe	Phosphor bronze and stainless steel springs are available

## 13 THE SECOND HAND GRIP

---

The Second Hand Grip is an optional accessory which can enhance the use of the instrument.

The grip is fitted between the high voltage probe handle and the probe accessory and enables the high voltage probe handle to be held by both hands, rather than just one:

- Allows the user to hold heavy probe accessories or long extension rods with greater ease and for longer periods of time.
- Highly insulated - does not affect the safe use of the instrument.
- Serves as a 0.5m extension rod.

### Description

Second Hand Grip

### Part Number

T26620081

### To fit the Second Hand Grip:

- 1 Slide the grip onto the end of the high voltage handle.
- 2 Rotate anti-clockwise until it is firmly screwed in place.

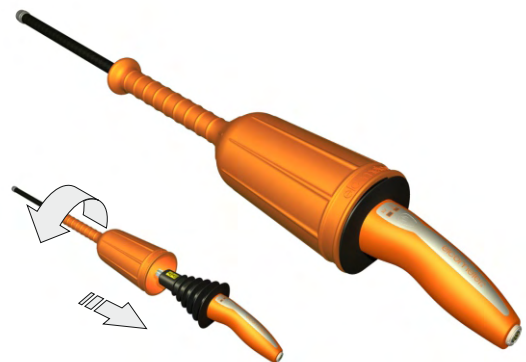

The probe accessory is then attached to the end of the Second Hand Grip using the standard coupling.

## 14 SPECIAL CONSIDERATIONS

---

### 14.1 CONDUCTIVE COATINGS

If the displayed voltage drops sharply when the probe is applied to the test surface or the alarm sounds continuously, then the coating may be conductive. The usual occurrences of conductive coatings are described in the following.

- **Existence of metallic, carbon or other conducting particles in the coating:** During normal use, the particles in this type of coating are not linked. However, when the coating is subjected to high voltages the material between the particles can break down. This results in the coating becoming conductive and the detector indicating the presence of a flaw.

## 14 SPECIAL CONSIDERATIONS (continued)

---

- **Surface moisture or contamination:** Certain soluble salts attract moisture from the atmosphere and this and other forms of surface contamination can form a path across the surface to the high voltage that is not due to a coating flaw. Under these conditions the detector indicates non-existent flaws. When these circumstances occur, the surface should either be dried using a suitable cloth or cleaned with a non-conducting cleaner or solvent which will not damage the coating.

*Note: Ensure that any cleaner or solvent containers are removed from the test area before re-commencing the test.*

- **Moisture penetration or absorption:** Moisture can enter materials, e.g. glass reinforced plastic along the reinforcing glass fibres, if the surface is eroded or scratched and then immersed in water. In this case, allow adequate time for the coating to dry prior to testing.
- **Rubber linings:** These may be slightly conductive due to their carbon content. As with other conductive coatings, reduce the sensitivity so that the detector indicates a known flaw but does not sound when the probe is placed on sound coating. It may also be necessary to increase the test voltage to compensate for the current flow through the coating.
- **Coating may not be fully cured:** In this case the coating still contains solvents which allow the path to the high voltage to be formed even if a flaw is not present. To overcome this problem, allow the coating to cure before undertaking the test.

### 14.2 CONCRETE SUBSTRATES

If a concrete or cement substrate contains enough moisture, then it will conduct electricity and the holiday detector can be used to detect flaws in its coating.

The procedure is generally the same as that described in 'Preparing For Test' on page en-14 and 'Test Procedure' on page en-16, but the following points should be noted. Hammering a masonry nail, or similar conducting spike, into the concrete or cement makes the earth signal return contact.

## 14 SPECIAL CONSIDERATIONS (continued)

The suitability of the concrete for use with a holiday detector can be checked using the following:

- 1 Make a high voltage return contact by hammering a nail or similar into the concrete.
- 2 Attach the earth signal return cable to the nail, set test voltage for the thickness of coating, or in the range 3 kV - 6 kV if the test voltage is not known and set the sensitivity to maximum (5  $\mu$ A current).
- 3 Place the probe on uncoated concrete about 4m (13ft) from the nail.

If the alarm sounds, then the concrete is sufficiently conductive. If the concrete is too dry, i.e. the alarm does not sound, then it is unlikely that the holiday detector will be a suitable inspection method.

### 14.3 LENGTHENING THE EARTH SIGNAL RETURN CABLE

Lengthening the return lead by connecting several leads together may invalidate the EMC performance of the equipment.

## 15 ERROR MESSAGES

Under certain conditions the instrument will display error messages. These messages are normally cleared by pressing one of the keys. The cause of the error will be indicated by the message and should be corrected before proceeding, see Table 4.

<b>Error Message</b>	<b>Causes</b>	<b>Action to Take</b>
SPARKING TO CASE	Current is returning from the probe to the instrument via a route other than the earth signal return cable.	Check that all cables are connected correctly. If the instrument is in contact with the item being tested, move it to a location isolated from the item. Ensure that you are not touching the probe against the metal connector at the end of the high voltage handle connecting cable.
00	High voltage probe handle device error.	Remove high voltage probe handle and refit. If error persists, contact Elcometer <sup>d</sup> .

<sup>d</sup> Or your local Elcometer supplier.

**15 ERROR MESSAGES (continued)**

<b>TABLE 4 (continued)</b>		
<b>Error Message</b>	<b>Causes</b>	<b>Action to Take</b>
01, 02 and 03	High voltage probe handle ADC error.	Remove high voltage probe handle and refit. If error persists, contact Elcometer <sup>d</sup> .
04, 05 and 06	High voltage probe handle DAC error.	Remove high voltage probe handle and refit. If error persists, contact Elcometer <sup>d</sup> .
07 and 08	High voltage probe handle EEPROM error.	Remove high voltage probe handle and refit. If error persists, contact Elcometer <sup>d</sup> .
09	High voltage probe handle CRC error.	Remove high voltage probe handle and refit. If error persists, contact Elcometer <sup>d</sup> .
10	High voltage probe handle connecting cable (curly cable) fault.	Return high voltage probe handle to Elcometer <sup>d</sup> .
11	Current leakage.	Return to Elcometer <sup>d</sup> for software upgrade.
12	Handle not compatible.	Remove high voltage probe handle and refit. If error persists, contact Elcometer <sup>d</sup> .
13	Handle data invalid.	Remove high voltage probe handle and refit. If error persists, contact Elcometer <sup>d</sup> .
14	Handle not recognised.	Remove high voltage probe handle and refit. If error persists, contact Elcometer <sup>d</sup> .
15, 16 and 17	Handle switch presses not recognised.	Remove high voltage probe handle and refit. If error persists, contact Elcometer <sup>d</sup> .

<sup>d</sup> Or your local Elcometer supplier.

## 16 SPARES & ACCESSORIES

### 16.1 HIGH VOLTAGE PROBE HANDLES

A range of interchangeable high voltage probe handles is available depending on the voltage required. The Elcometer 266 is not supplied with a probe handle, these must be ordered separately.



For further information regarding connecting and using a high voltage probe handle, see Section 6 'High Voltage Probe Handle' on page en-11.

Description	Voltage	Part Number*
Elcometer 266 Probe Handle, DC5	0.5 - 5 kV	T26620033-1
Elcometer 266 Probe Handle, DC15	0.5 - 15 kV	T26620033-2
Elcometer 266 Probe Handle, DC30	0.5 - 30 kV	T26620033-3
Elcometer 266 Probe Handle, DC30S (Continuous Voltage)	0.5 - 30 kV	T26620033-4

\* Add 'C' to the end of the part number for a probe handle supplied complete with calibration certificate.

*Note: The DC30S Continuous Voltage Probe Handle is compatible with Elcometer 266 instruments with serial numbers 'SC16119' onwards. The software in older instruments must be updated by Elcometer or your local Elcometer distributor to recognise the new DC30S handle.*

### 16.2 SECOND HAND GRIP

Ideal for testing pipes and tank floors with two hands - without compromising safety.

For further information regarding the second hand grip, see Section 13 on page en-23.

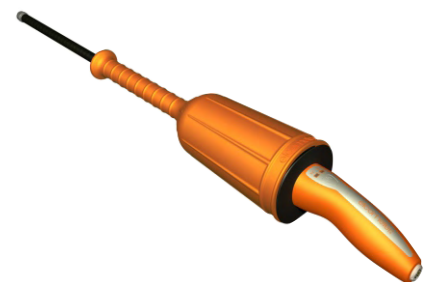

**Description**  
Second Hand Grip

**Part Number**  
T26620081

## 16 SPARES & ACCESSORIES (continued)

### 16.3 BATTERIES, CHARGERS & EARTH SIGNAL RETURN LEADS

Description	Part Number
Rechargeable Lithium Ion Battery Pack	T99923482
Battery Charger (with UK, EU, US & AUS plugs)	T99919999
Earth Signal Return Lead; 4m (13')	T99916954
Earth Signal Return Lead; 10m (32')	T99916996

### 16.4 PROBE EXTENSION RODS

Description	Part Number
Probe Extension Piece; 250mm (9.8")	T99919988-3
Probe Extension Piece; 500mm (20")	T99919988-1
Probe Extension Piece; 1000mm (39")	T99919988-2



### 16.5 ACCESSORY ADAPTORS

Allow other manufacturer's accessories to be used with the Elcometer 266.

Adaptor for Models	Part Number
AP, APS, AP/S1, AP/S2, AP/W, 10/20, 14/20, 10, 20 & 20S	T99920084
P20, P40, P60, 780, 785 & 790	T99920083
PHD 1-20 & PHD 2-40	T99920252
Elcometer 266 with old Elcometer Accessories	T99920082

### 16.6 BAND BRUSH PROBES



Description	Part Number
Band Brush Probe	T99919975
Band Brush Probe; Phosphor Bronze	T99922751

### 16.7 RIGHT ANGLED WIRE BRUSH PROBES



Complete Assembly		Spare Electrode Only	
Part Number	Width	Part Number	Width
T99920022-1	250mm (9.8")	T99926621	250mm (9.8")
T99920022-2	500mm (19.7")	T99926622	500mm (19.7")
T99920022-3	1000mm (39")	T99926623	1000mm (39")



**16 SPARES & ACCESSORIES (continued)**

**16.8 INTERNAL CIRCULAR WIRE PIPE BRUSH PROBES**

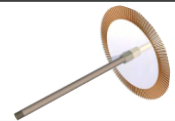

Complete Assembly		Spare Electrode Only	
Part Number	Diameter	Part Number	Diameter
T99920071-1	38mm (1.5")	T9993766-	38mm (1.5")
T99920071-2	51mm (2.0")	T9993767-	51mm (2.0")
T99920071-3	64mm (2.5")	T9993768-	64mm (2.5")
T99920071-4	76mm (3.0")	T9993769-	76mm (3.0")
T99920071-5	89mm (3.5")	T9993770-	89mm (3.5")
T99920071-6	102mm (4.0")	T9993771-	102mm (4.0")
T99920071-7	114mm (4.5")	T9993772-	114mm (4.5")
T99920071-8	127mm (5.0")	T9993773-	127mm (5.0")
T99920071-9	152mm (6.0")	T9993774-	152mm (6.0")
T99920071-10	203mm (8.0")	T9993775-	203mm (8.0")
T99920071-11	254mm (10")	T9993776-	254mm (10")
T99920071-12	305mm (12")	T9993777-	305mm (12")
T99920071-13	356mm (14")	T9993778-	356mm (14")
T99920071-14	406mm (16")	T9993779-	406mm (16")
T99920071-15	508mm (20")	T9993780-	508mm (20")
T99920071-16	610mm (24")	T9993781-	610mm (24")

**16.9 'C-TYPE' WIRE BRUSHES**

'C-Type' wire brushes are not supplied with a holder as standard. Please order the holder separately.

A wire brush support handle is also available - ideal for two handed use or second person when using larger diameter wire brushes.



**Description**

'C-Type' Wire Brush Holder  
 'C-Type' Wire Brush Support Handle

**Part Number**  
 T99922752  
 T99922907

## 16 SPARES & ACCESSORIES (continued)

‘C-Type’ Wire Brushes					
Part Number	Outside Diameter		Part Number	Outside Diameter	
	DN	NPS		DN	NPS
T99922745-1	150 - 250mm	6 - 9"	T99922745-6	650 - 750mm	24 - 28"
T99922745-2	250 - 350mm	9 - 12"	T99922745-7	750 - 850mm	28 - 32"
T99922745-3	350 - 450mm	12 - 16"	T99922745-8	850 - 950mm	32 - 36"
T99922745-4	450 - 550mm	16 - 20"	T99922745-9	950 - 1050mm	36 - 40"
T99922745-5	550 - 650mm	20 - 24"	T99922745-10	1050 - 1150mm	40 - 44"

### 16.10 CONDUCTIVE RUBBER PROBES

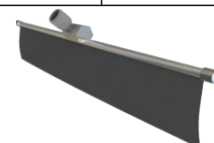

Complete Assembly		Spare Electrode Only	
Part Number	Width	Part Number	Width
T99920022-11	250mm (9.8")	T99926731	250mm (9.8")
T99920022-12	500mm (19.7")	T99926732	500mm (19.7")
T99920022-13	1000mm (39")	T99926733	1000mm (39")
T99920022-14	1400mm (55")	T99926734	1400mm (55")

### 16.11 ROLLING SPRINGS

Available in phosphor bronze or stainless steel, each spring is supplied with an easy release coupling piece allowing users to quickly connect and disconnect the rolling spring at stanchions, pillars, etc.

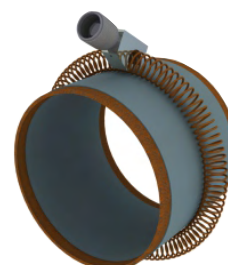

Rolling springs are not supplied with a holder as standard. Please order the appropriate holder separately.

The 19mm (0.75") diameter phosphor bronze springs are almost three times lighter than the 34mm (1.33") diameter stainless steel springs.

#### Description

Phosphor Bronze Rolling Spring Holder  
Stainless Steel Rolling Spring Holder

#### Part Number

T99920086  
T99922746

**16 SPARES & ACCESSORIES (continued)**

Part Number		Nominal Pipe Size		Pipe Outside Diameter (OD)			
Phosphor Bronze	Stainless Steel	DN (mm)	NPS (inches)	Min (mm)	Max (mm)	Min (inches)	Max (inches)
T99920438-15A	-	40	1.5	48	54	1.9	2.1
T99920438-15B	-			54	60	2.1	2.4
T99920438-20A	-	50	2.0	60	66	2.4	2.6
T99920438-20B	-			66	73	2.6	2.9
T99920438-25A	T99922744-25A	65	2.5	73	80	2.9	3.1
T99920438-25B	T99922744-25B			80	88	3.1	3.5
T99920438-30A	T99922744-30A	80	3.0	88	95	3.5	3.7
T99920438-30B	T99922744-30B			95	100	3.7	3.9
T99920438-35A	T99922744-35A	90	3.5	100	108	3.9	4.3
T99920438-35B	T99922744-35B			108	114	4.3	4.5
T99920438-40A	T99922744-40A	100	4.0	114	125	4.5	4.9
T99920438-45A	T99922744-45A	114	4.5	125	136	4.9	5.4
T99920438-45B	T99922744-45B			136	141	5.4	5.6
T99920438-50A	T99922744-50A	125	5.0	141	155	5.6	6.1
T99920438-50B	T99922744-50B			155	168	6.1	6.6
T99920438-60A	T99922744-60A	152	6.0	168	180	6.6	7.1
T99920438-60B	T99922744-60B			180	193	7.1	7.6
T99920438-70A	T99922744-70A	178	7.0	193	213	7.6	8.4
T99920438-70B	T99922744-70B			213	219	8.4	8.6
T99920438-80A	T99922744-80A	203	8.0	219	240	8.6	9.4
T99920438-90A	T99922744-90A	229	9.0	240	264	9.4	10.4
T99920438-100A	T99922744-100A	254	10.0	264	290	10.4	11.4
T99920438-110A	T99922744-110A	279	11.0	290	320	11.4	12.6
T99920438-120A	T99922744-120A	305	12.0	320	350	12.6	13.8
T99920438-140A	T99922744-140A	356	14.0	350	375	13.8	14.8
T99920438-140B	T99922744-140B			375	400	14.8	15.7
T99920438-160A	T99922744-160A	406	16.0	400	435	15.7	17.1
T99920438-160B	T99922744-160B			435	450	17.1	17.7

**16 SPARES & ACCESSORIES (continued)**

Part Number		Nominal Pipe Size		Pipe Outside Diameter (OD)			
Phosphor Bronze	Stainless Steel	DN (mm)	NPS (inches)	Min (mm)	Max (mm)	Min (inches)	Max (inches)
T99920438-180A	T99922744-180A	457	18.0	450	500	17.7	19.7
T99920438-200A	T99922744-200A	508	20.0	500	550	19.7	21.7
T99920438-220A	T99922744-220A	559	22.0	550	600	21.7	23.6
T99920438-240A	T99922744-240A	610	24.0	600	650	23.6	25.6
T99920438-260A	T99922744-260A	660	26.0	650	700	25.6	27.6
T99920438-280A	T99922744-280A	711	28.0	700	750	27.6	29.5
T99920438-300A	T99922744-300A	762	30.0	750	810	29.5	31.9
T99920438-320A	T99922744-320A	813	32.0	810	860	31.9	33.9
T99920438-340A	T99922744-340A	864	34.0	860	910	33.9	35.8
T99920438-360A	T99922744-360A	914	36.0	910	960	35.8	37.8
T99920438-380A	T99922744-380A	965	38.0	960	1010	37.8	39.8
T99920438-400A	T99922744-400A	1016	40.0	1010	1060	39.8	41.7
T99920438-420A	T99922744-420A	1067	42.0	1060	1110	41.7	43.7
T99920438-440A	T99922744-440A	1118	44.0	1110	1160	43.7	45.7
T99920438-460A	T99922744-460A	1168	46.0	1160	1210	45.7	47.6
T99920438-480A	T99922744-480A	1219	48.0	1210	1270	47.6	50.0
T99920438-500A	T99922744-500A	1270	50.0	1270	1320	50.0	52.0
T99920438-520A	T99922744-520A	1321	52.0	1320	1370	52.0	53.9
T99920438-540A	T99922744-540A	1372	54.0	1370	1425	53.9	56.1

**17 WARRANTY STATEMENT**

The Elcometer 266 DC Holiday Detector and High Voltage Probe Handles are supplied with a 12 month warranty against manufacturing defects, excluding contamination and wear.

The warranty can be extended to two years within 60 days of purchase via [www.elcometer.com](http://www.elcometer.com).

## 18 TECHNICAL SPECIFICATION

<b>Output Voltage<sup>e</sup></b>	0.5 kV to 5 kV 0.5 kV to 15 kV 0.5 kV to 30 kV	
<b>High Voltage Output Accuracy</b>	±5% or ±50 V below 1 kV	
<b>Measured Current Flow Accuracy</b> (sensitivity)	±5% of full scale	
<b>Display Resolution</b>	Voltage - Measured:	0.01 kV below 10 kV; 0.1 kV above 10 kV
	Voltage - Set:	0.05 kV below 1 kV; 0.1 kV above 1 kV
	Current - Measured:	1µA
	Current - Set:	1µA
<b>Output Current</b>	99µA Maximum	
<b>Operating Temperature</b>	0 to 50°C (32 to 122°F)	
<b>Power Supply<sup>f</sup></b>	Internal rechargeable lithium ion battery	
<b>Battery Life<sup>g</sup></b>	8/10 hours continuous use at 30 kV 15/20 hours continuous use at 15 kV 20/40 hours continuous use at 5 kV	
<b>Battery Charger Fuse Rating (if fitted)</b>	3 A	
<b>Weight</b>	Base Unit: (including battery pack)	1.2kg (2.7lb)
	Handle:	0.6kg (1.3lb)
	Base Unit, Handle & Connecting Cable:	2kg (4.4lb)
<b>Kit Dimensions</b>	520 x 370 x 125mm (20.5 x 14.5 x 5")	
Can be used in accordance with: See Appendix A 'Standards' on page en-35.		

<sup>e</sup> Depending on which high voltage handle is fitted.

<sup>f</sup> Battery packs must be disposed of carefully to avoid environmental contamination. Please consult your local environmental authority for information on disposal in your region. Do not dispose of the battery pack in a fire.

<sup>g</sup> Typical battery life with or without backlight.

## 19 CARE & MAINTENANCE

---

- The gauge incorporates a Liquid Crystal Display (LCD). If the display is heated above 50°C (120°F) it may be damaged. This can happen if the gauge is left in a car parked in direct sunlight.
- Keep the instrument, high voltage probe handle, connecting cables and probe accessories clean. Before cleaning, switch off the instrument and disconnect all cables. To clean, wipe with a damp cloth and then allow ample time to air dry before use. Do not use any solvents to clean the instrument.
- At regular intervals, check the instrument, high voltage probe handle, probe and high voltage return leads and connectors for damage. Replace any parts that are worn or are of doubtful condition, see Section 16 'Spares & Accessories' on page en-27.
- Regular calibration checks over the life of the instrument are a requirement of quality management procedures, e.g. ISO 9000, and other similar standards. For checks and certification contact Elcometer or your Elcometer supplier.

The instrument does not contain any user-serviceable components. In the unlikely event of a fault, the gauge should be returned to your local Elcometer supplier or directly to Elcometer. The warranty will be invalidated if the gauge has been opened.

## 20 LEGAL NOTICES & REGULATORY INFORMATION

---

This product meets the Electromagnetic Compatibility Directive and the Low Voltage Directive.

This product is Class A, Group 1 ISM equipment according to CISPR 11.

Group 1 ISM product: A product in which there is intentionally generated and/or used conductively coupled radiofrequency energy which is necessary for the internal functioning of the equipment itself.

Class A product: Suitable for use in all establishments other than domestic and those directly connected to a low voltage power supply network which supplies buildings used for domestic purposes.

**NOTE: Additional information is given in Section 1 'Working Safely' on page en-2.**

Product Description: Elcometer 266 DC Holiday Detector

Manufactured by: Elcometer Limited, Manchester, England.

elcometer® is a registered trademark of Elcometer Limited, Edge Lane, Manchester, M43 6BU.  
United Kingdom

All other trademarks acknowledged.

The Elcometer 266 DC Holiday Detector is packed in cardboard and plastic packaging. Please ensure that this packaging is disposed of in an environmentally sensitive manner. Consult your local Environmental Authority for further guidance.

## APPENDIX A: STANDARDS

The voltage calculator included in the Elcometer 266 DC Holiday Detector is programmed with the following standards:

ASTM G6-83	AS3894.1:F3 1991	NACE SP0188-2006
ASTM G62-87	AS3894.1:F4 1991	NACE SP0490-2007
AS3894.1:F1 1991	ANSI/AWWA C213-91	NACE RP0274-04
AS3894.1:F2 1991	EN14430:2004	

Other standards which do not derive the test voltage directly from the coating thickness are not available within the Voltage Calculator function. Testing to these standards is still possible however, by setting the test voltage manually - see Section 9.2 'Manually Setting the Voltage' on page en-18.

The Elcometer 266 DC Holiday Detector can be used in accordance with the following list of standards and test methods:

Standard or Method Number	Date	Title	Notes	Voltage Setting <sup>†</sup>
ANSI/AWWA C214-89	1990	Tape coating systems for the exterior of steel water pipes	Minimum voltage is 6 kV. Use NACE RP0274	M
ANSI/AWWA C214-89	1992	Fusion-bonded epoxy coating for the interior and exterior of steel water pipes	$V = 525 \cdot \sqrt{\text{Thickness (mil)}}$	VC, M
AS3894.1	1991	Site testing of protective coatings. Method 1: Non-conductive coatings - Continuity test - High voltage (brush) method	Testing coatings >150µm at voltages >500 V  $V = 250 \cdot \sqrt{\text{Thickness (µm)}} / \text{factor}$	VC, M
ASTM D4787	1988	Continuity verification of liquid or sheet linings applied to concrete	High voltage (above 900 V) test. Set voltage below dielectric breakdown strength of lining. Move probe at 0.3m/s (1 ft/s) max.	M

<sup>†</sup> Elcometer 266 Voltage Setting: VC = Voltage Calculator; M = Manual



**APPENDIX A: STANDARDS (continued)**

Standard or Method Number	Date	Title	Notes	Voltage Setting <sup>†</sup>
ASTM F423	1975	PTFE plastic-lined ferrous metal pipe and fittings	Electrostatic test: 10 kV, spark at defect is cause for rejection	M
ASTM G6	1983	Abrasion resistance of pipeline coatings	Porosity test prior to abrasion testing. Test voltage is calculated as $V = 1250 \cdot \sqrt{\text{Thickness (mil)}}$	VC, M
ASTM G62-B	1987	Holiday detection in pipeline coatings	Method B. Thickness <1.016mm $= 3294 \cdot \sqrt{\text{Thickness (mm)}}$ Thickness >1.041mm $= 7843 \cdot \sqrt{\text{Thickness (mm)}}$	VC, M
BS 1344-11	1998	Methods of testing vitreous enamel finishes Part II: High voltage test for articles used under highly corrosive conditions	Same as ISO 2746 (Test voltage above 2 kV for enamel thicker than 220µm)	M
EN 14430	2004	Vitreous and porcelain enamels - High Voltage Test	DC or pulsed test voltage. $V = 1.1 \text{ kV to } 8.0 \text{ kV}$ for thicknesses of 100µm to 2000µm	VC, M
ISO 2746	2014	Vitreous and porcelain enamels - Enamelled articles for service under highly corrosive conditions - High voltage test	Test voltage above 2 kV for enamel thicker than 220µm	M
ISO 29601	2011	Corrosion protection by protective paint systems - Assessment of porosity in a dry film	Low and high voltage equipment and test	M
JIS G-3491	1993	Asphalt coatings on water line pipes	Inside walls: 8-10 kV Dipped Coatings: 6-7 kV Outside walls: 10-12 kV	M

<sup>†</sup> Elcometer 266 Voltage Setting: VC = Voltage Calculator; M = Manual

**APPENDIX A: STANDARDS (continued)**

Standard or Method Number	Date	Title	Notes	Voltage Setting <sup>†</sup>
JIS G-3492	1993	Coal-tar enamel coatings on water line pipes	Inside walls: 8-10 kV Dipped coatings: 6-7 kV Outside walls: 10-12 kV Welded areas as inside walls	M
NACE SP0188	2006	Discontinuity (Holiday) Testing of new Protective Coatings on Conductive Substrates	Low and high voltage equipment and tests.	VC, M
NACE RP0274	1974	High Voltage Electrical Inspection of Pipeline Coatings prior to installation	DC or Pulsed test voltage $V = 1250 \cdot \sqrt{\text{Thickness (mil)}}$	VC, M
NACE SP0490	2007	Holiday Detection of Fusion-Bonded Epoxy External Pipeline Coatings of 10-30mils (0.25 - 0.76mm)	DC in dry conditions $V = 525 \cdot \sqrt{\text{Thickness (mil)}}$ Trailing ground lead of 9m allowed if pipe is connected to 2-3ft earth spike and soil is not dry	VC, M
<p><i>Note: The above list and comments have been extracted from the documents identified and every effort has been made to ensure that the content is correct. No responsibility can be accepted, however, for the accuracy of the information as these documents are updated, corrected and amended regularly. A copy of the relevant standard or method must be obtained from the source to ensure that it is the current document.</i></p>				

<sup>†</sup> Elcometer 266 Voltage Setting: VC = Voltage Calculator; M = Manual

## **APPENDIX B: CALCULATING THE CORRECT TEST VOLTAGE**

---

The Elcometer 266 includes a built-in voltage calculator which will determine and set the correct test voltage based upon the test standard and the thickness of coating you are testing, see Section 9.1 'Automatically Setting the Voltage' on page en-17.

Alternatively, the voltage can be set by the user, see Section 9.2 'Manually Setting the Voltage' on page en-18, using the following guidelines which describe how a safe, but effective, test voltage may be determined.

### **OVERVIEW**

For effective testing, the test voltage must lie between two limits - the upper and lower limits.

- The upper voltage limit is that at which the coating itself would breakdown and be damaged. Therefore, the test voltage should be lower than this value.
- The lower limit is the voltage required to break down the thickness of air equivalent to the coating thickness. If the output voltage is not greater than this value, then a flaw will not be detected.

These two limits can be determined and a voltage approximately half way between them selected as the test voltage.

### **DIELECTRIC STRENGTH**

Whatever the material, if a high enough voltage is applied, it will conduct electricity. However, for insulators, such as paint, the level of voltage required to achieve a current flow usually results in irreversible material damage.

The voltage at which a particular thickness of material breaks down is termed the dielectric strength. This is usually expressed as the voltage per unit distance, e.g. kV/mm.

Its value depends on the type of applied voltage (AC, DC or pulsed), temperature and thickness. The graph on page en-39 shows the relationship between breakdown voltage (DC) and thickness for materials of different dielectric strengths.

## APPENDIX B: CALCULATING THE CORRECT TEST VOLTAGE (cont)

The upper voltage limit is the dielectric strength of the material multiplied by its thickness and the lower voltage limit is the dielectric strength of air multiplied by the thickness.

The dielectric strength of coating materials usually lies in the region of 10 kV/mm to 30 kV/mm. The dielectric strength of air ranges from 1.3 kV/mm to 4 kV/mm.

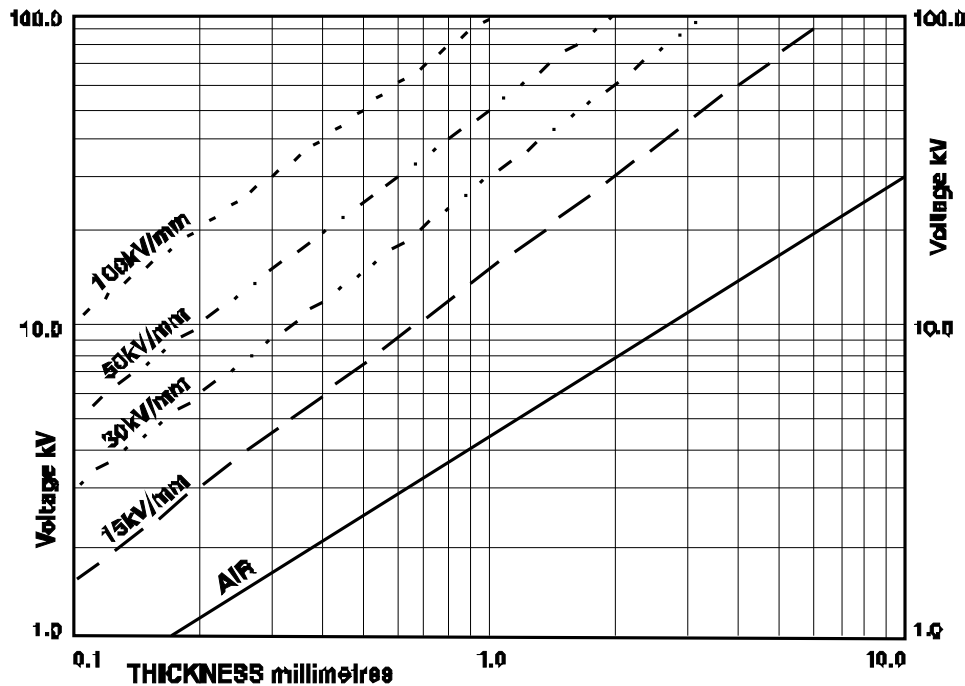

**Breakdown voltage against thickness for materials of different dielectric strengths:** This graph is useful if you do not have a standard to work to and wish to know more about how to establish a test voltage.

### ESTABLISHING THE VOLTAGE LIMITS

**The Lower Limit:** The lower limit for effective operation is that required to breakdown the thickness of air equivalent to the coating thickness. The breakdown voltage of a given thickness of air varies with humidity, pressure and temperature but is approximately 4 kV/mm (0.1 kV/mil).

If the coating thickness is known, or can be measured, the lower limit value can be read from the graph given above, using the line marked AIR. For instance, if the coating thickness is 1.0mm then the lower limit is approximately 4.5 kV.

## APPENDIX B: CALCULATING THE CORRECT TEST VOLTAGE (cont)

If the coating thickness is not known then the minimum value has to be established experimentally. Reduce the voltage setting to minimum and position the probe over an unprotected area of substrate at the normal height of the coating surface. Increase the voltage slowly and steadily until a spark is produced. Make a note of this voltage - it is the lower voltage limit.

**The Upper Limit:** The upper voltage limit may be determined by:

- *The job specification* - if available and a test voltage is stated.
- *The dielectric strength* - if specified for the applied coating. Measure the thickness of the layer and refer to the graph on page en-39. Alternatively, calculate the maximum voltage, allowing for variations in the coating thickness. Note that 1 kV per mm is equivalent to 25.4 V per mil (thou).

*Note: This method is only suitable if the dielectric strength values were determined for a DC voltage.*

- *Experiment* - Touch the probe on an unimportant area of the work piece. Increase the voltage slowly and steadily until a spark passes through the coating. Make a note of this voltage - it is the upper voltage limit. (The dielectric strength can be calculated by dividing this voltage by the coating thickness).
- *Tables and formulae* - from established Codes of Practice, e.g. NACE and ASTM. Examples of tables are given below (see Table 1, Table 2 and Table 3). See also Section 9.1 'Automatically Setting the Voltage' on page en-17 and Appendix A 'Standards' on page en-35.

Once the lower and upper voltage limits have been established, set the voltage approximately halfway between the two values.

**APPENDIX B: CALCULATING THE CORRECT TEST VOLTAGE (cont)**

<b>TABLE 1: kV values from ASTM G62-87 (up to 1 mm)</b>			
<b>Microns</b>	<b>Kilovolts (kV)</b>	<b>Thou/Mils</b>	<b>Kilovolts (kV)</b>
100	1.04	5	1.17
200	1.47	10	1.66
300	1.80	15	2.03
400	2.08	20	2.34
500	2.33	25	2.63
600	2.55	30	2.88
700	2.76	35	3.11
800	2.95	40	3.32
900	3.12	-	-
1000	3.29	-	-

<b>TABLE 2: kV values from ASTM G62-87 (above 1 mm)</b>			
<b>mm</b>	<b>Kilovolts (kV)</b>	<b>Thou/Mils</b>	<b>Kilovolts (kV)</b>
1	7.84	40	7.91
2	11.09	80	11.18
3	13.58	120	13.69
4	15.69	160	15.81
5	17.54	200	17.68
6	19.21	240	19.36
7	20.75	280	20.92

<b>TABLE 3: kV values from NACE RP0188-99</b>		
<b>mm</b>	<b>Thou/Mils</b>	<b>Kilovolts (kV)</b>
0.20 to 0.28	8 – 11	1.5
0.30 to 0.38	12 – 15	2.0
0.40 to 0.50	16 – 20	2.5
0.53 to 1.00	21 – 40	3.0
1.01 to 1.39	41 – 55	4.0
1.42 to 2.00	56 – 80	6.0
2.06 to 3.18	81 – 125	10.0
3.20 to 3.43	126 – 135	15.0





